

Custom
ELEVATOR



MANUFACTURERS

OF FINE

CUSTOM

Residential
Elevators

TABLE OF CONTENTS

PG 1 INTRODUCTION



PG 2 PREMIER SERIES



PG 3 SIGNATURE SERIES



PG 4 HAMPTON SERIES



PG 5 CLASSIC SERIES

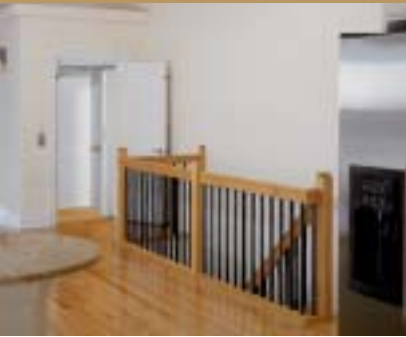

PG 6 PREMIER CAB OPTIONS



PG 7 SIGNATURE CAB OPTIONS



PG 8 HAMPTON CAB OPTIONS



PG 9 CLASSIC CAB OPTIONS



**PG 10 CAB OPTIONS:
CEILING, LAMP,
& COLOR SELECTIONS**



**PG 11&12 OTHER DESIGN
OPTIONS: HANDRAILS, FIXTURES
& ACCORDION DOORS**



**PG 13
STANDARD
FEATURES**

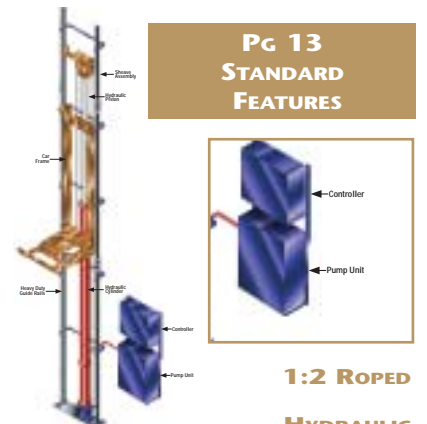

**1:2 ROPED
HYDRAULIC**

Many thanks to RVO Photography and the builders of fine homes depicted throughout this catalog: Astley Inc., ERNST & ERNST and Grande Custom Homes

WHY CHOOSE

A HOME ELEVATOR?

- Mobility/Access to All Levels of a Home Forever
- Efficient Use of Space
- Convenience
- Affordable
- Increases Home Resale Value
- Touch of Luxury

Add the convenience of an elevator to your home and enjoy a more relaxed lifestyle. Many homeowners are now finding a residential elevator is a wise investment for the future and for their homes' resale value. Whether you live in the cold mountains of Colorado or the warm shores of Florida, Custom Elevator Manufacturing Company has the capability to manufacture an elevator that fits your home.

Our unique design offers the flexibility to customize our standard system to suit most any conditions making our products perfect for new construction, or for any existing home remodeling project.



HOME ELEVATORS



OUR MISSION

The founders of Custom Elevator Manufacturing Company, who provided the first roped hydraulic residential elevator to enter the market, are back to introduce the finest line of residential elevators available. With strong roots in every facet of the elevator industry, we set out to utilize our experience to provide residential elevator systems that are unparalleled in the industry.

Focusing on *service beyond the sale*, we provide our clients with superior products and support to assure an efficient and quality installation. Our commitment to quality control, code compliance, and unique craftsmanship offers our customers the most dependable, safe, and attractive elevator system on the market today, adding to the overall appeal of the home that will last a lifetime.

PREMIER CAB SERIES

When only the best will do, our top-of-the-line Premier cab evokes the elegance and sophistication of fine furniture. Adorned with real wood raised panels in your choice of stains, the Premier is dressed to impress the most discriminating homeowners and their guests.



SEE PAGE 6 FOR PREMIER CAB OPTIONS

SIGNATURE CAB SERIES

Our distinctive Signature cab offers the ultimate in versatility, with a wide variety of custom design options for a personalized, one-of-a-kind look. Choose a wood stain or paint, mirror or arch, and many other selections to create your own Signature style.



SEE PAGE 7 FOR SIGNATURE CAB OPTIONS

HAMPTON CAB SERIES

For those who prefer a simple yet graceful design, our Hampton cab features clean lines, traditional moldings and a high quality wood finish. Available in various woods and stains, the Hampton harmonizes beautifully with the décor of older homes and new homes alike.



SEE PAGE 8 FOR HAMPTON CAB OPTIONS

CLASSIC CAB SERIES

Offering the perfect balance of form, function and value, the Classic cab is our most affordable model. With durable, easy-to-clean laminate walls in an extensive array of colors and patterns, the Classic meets the practical needs of multi-unit residences and cost-conscious homeowners.

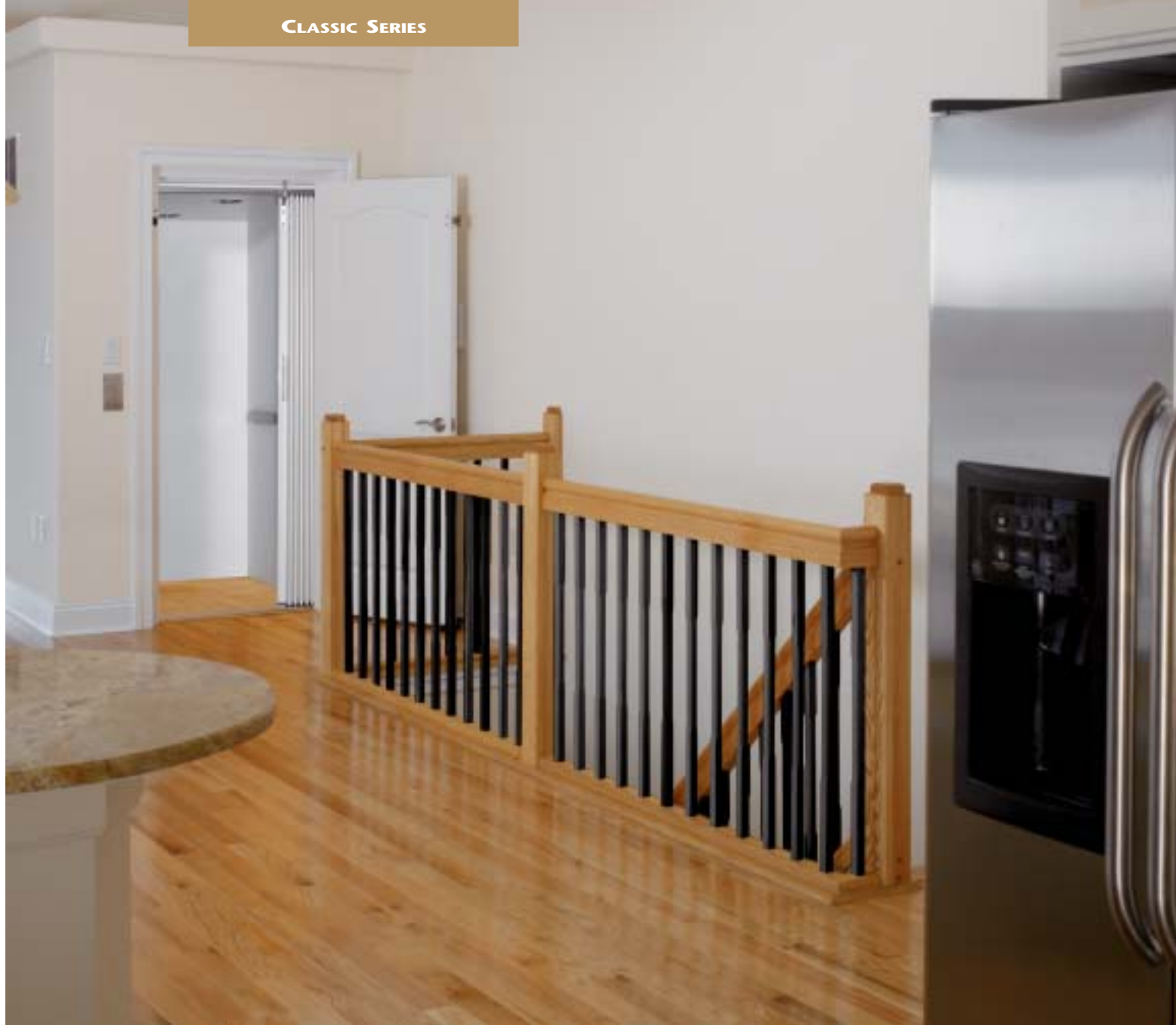

SEE PAGE 9 FOR CLASSIC CAB OPTIONS

PREMIER CAB OPTIONS

PREMIER SERIES

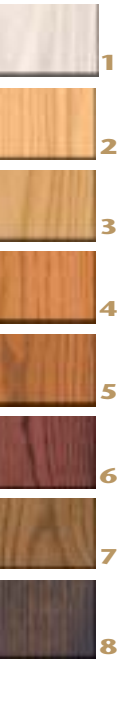

The Premier Series raised panel cab design is distinctively crafted from natural oak hardwood and veneers available in several stains and solid color lacquer finishes. Other available wood species include cherry, walnut, birch and mahogany. Laminated safety glass rear or side wall insert is optional. A wide variety of ceilings are available as shown. *



Optional (2) panel wall. (Standard for smaller wall panel sizes)



Wall shown with golden stain and lacquer finish

STANDARD

CEILING

CHOICES

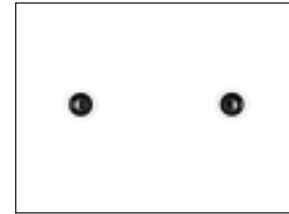

C-1



C-4



C-5



C-6

OPTIONAL

CEILING

CHOICES



C-3



C-7



C-12

(Ceilings C-4, C-5, C-6 & C-7 are not available with 80" inside cab height)



* See page 10 for ceiling descriptions & enlarged color selections. Additional options - handrails, signal fixtures & accordion doors shown on pages 11&12.



SIGNATURE SERIES

The Signature Series recessed panel cab design is elegantly crafted from natural oak hardwood and veneers available in several stains and solid color lacquer finishes. The look of this beautiful cab may be accented with the optional arched top panel or smoked mirror middle panel on the back or side wall. Other available wood species include cherry, walnut, birch and mahogany. Laminated safety glass rear or side wall insert is optional. Several ceiling choices can enhance the beauty of this cab to suit your taste. *



Optional arched top recessed panel



Optional recessed smoked mirror middle panel



Optional white lacquer finish shown



Wall shown with golden stain and lacquer finish

STANDARD CEILING CHOICES

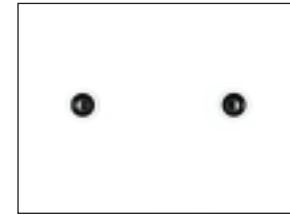

C-1



C-4



C-5

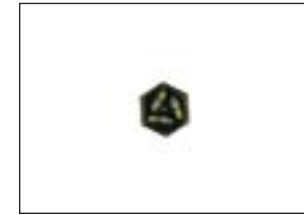

C-6

OPTIONAL CEILING CHOICES



C-3



C-7



C-8



C-9

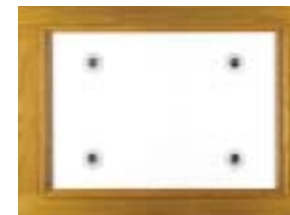

C-10



C-11



(Ceilings C-4, C-5, C-6, C-7 & C-11 are not available with 80" inside cab height)

HAMPTON CAB OPTIONS

HAMPTON SERIES

The Hampton Series oak veneer panel cab design is beautifully fitted with solid oak moldings available in several stains and solid color lacquer finishes. Other available wood species include cherry, walnut, birch and mahogany. A wide variety of ceilings are available as shown. *

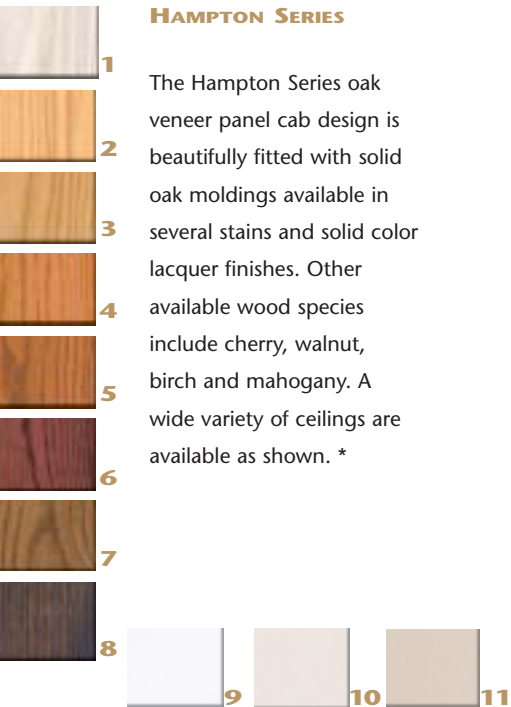

Wall shown with golden stain and lacquer finish

STANDARD

CEILING CHOICES

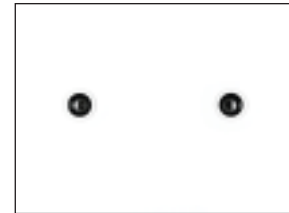

C-1



C-4



C-5



C-6

OPTIONAL

CEILING CHOICES



C-3



C-7

(Ceilings C-4, C-5, C-6 & C-7 are not available with 80" inside cab height)



* See page 10 for ceiling descriptions & enlarged color selections. Additional options - handrails, signal fixtures & accordion doors shown on pages 11&12.

MODEL LE

The Model LE is our offering for a low cost, high quality home elevator package.

By limiting the available options, we are able to keep your cost down without compromising the dependability, performance and ride quality that you have come to expect from our products.

Features

- Available with Hydraulic or Cable Drive
- 750 lbs capacity up to 12 sq.ft. car size
- Cab openings inline or front and rear
- Up to 3 stops with 30 feet of travel
- Melamine Cab Walls with 6'-8" clear height (7'-4" high optional)
- Vinyl laminate car door(s) is standard (vision panels, all clear & power operator(s) optional)
- Stainless Steel car station and handrail (stainless steel phone cabinet optional)
- C-1 ceiling is standard (C-2, C-3, C-4, C-5 & C-6 optional)



Cab shown : Maple finish with standard C-1 ceiling

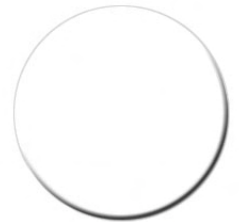

WHITE



MAHOGANY



CANDLELIGHT



PRESTIGE MAPLE

P.O. BOX 749
5191 STUMP ROAD
PLUMSTEADVILLE, PA 18949

TOLL FREE: 888-443-2800
PHONE: 215-766-3380
FAX : 215-766-3385

Custom **ELEVATOR**
WWW.CUSTOMELEVATORINC.COM

RALEIGH CAB

RALEIGH SERIES

The Raleigh Series is a simple three dimensional oak veneer panel cab with applied hardwood moldings available in a variety of stain color finishes. The Raleigh Cab offers the beauty of natural hardwood at an affordable price.



Cab shown: Cordovan finish with a standard C-1 ceiling.

**STANDARD
CEILING**

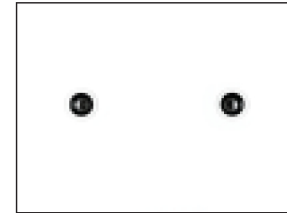

C-1

**OPTIONAL
CEILING
CHOICES**



C-2



C-3

WOOD

STAIN

SELECTIONS

NATURAL OAK 2



CORDOVAN 6



DARK OAK 7



WALNUT 8



Color samples are reproduced using modern printing techniques. Color and pattern may vary slightly.

P.O. BOX 749
5191 STUMP ROAD
PLUMSTEADVILLE, PA 18949

TOLL FREE: 888-443-2800
PHONE: 215-766-3380
FAX: 215-766-3385

WWW.CUSTOMELEVATORINC.COM

Custom
ELEVATOR

manufacturing
company, inc.

CLASSIC SERIES

The Classic Series cab offers our most durable panel design faced with 1/16" thick plastic laminate available in solid, textured, and woodgrain finishes. Laminated safety glass rear or side wall insert is optional. A variety of ceiling choices are available as shown. *



Plastic laminate wall shown with white laminate finish

**STANDARD
CEILING**

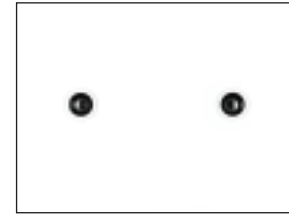

C-1

**OPTIONAL
CEILING
CHOICES**

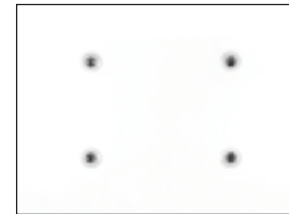

C-2



C-3

**STANDARD
PLASTIC
LAMINATE
INTERIOR
CHOICES**



(Consult factory for custom laminate choices other than shown here)

Color samples are reproduced using modern printing techniques. Color and pattern may vary slightly.

CEILING DESCRIPTIONS

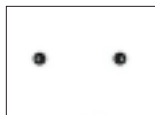

C-1 White melamine finish with (2) 4" diameter incandescent recessed down lights including white trim rings and black baffles. (6)



C-2 White melamine finish with (4) miniature low voltage recessed down lights including white trim rings. (5)



C-3 Black melamine finish with (4) miniature low voltage recessed down lights including polished brass trim rings. (4)



C-4 White melamine finish with 13" diameter, polished brass, clear ribbed glass light fixture. (3)



C-5 Black melamine finish with 12" diameter, polished brass, frosted white glass light fixture. (2)

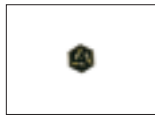

C-6 White melamine finish with 10" diameter, polished brass, (6) sided, beveled glass light fixture. (1)



C-7 Oak veneer with choice of stain and lacquer finish including 10" diameter, polished brass, (6) sided, beveled glass light fixture. (1)



C-8 Solid oak and veneer recessed panel with choice of stain or solid color lacquer finish including (4) miniature low voltage recessed down lights with polished brass trim rings. (4)



C-9 Solid oak and veneer with black melamine recessed panel with choice of stain and lacquer finish border including (4) miniature low voltage recessed down lights with polished brass trim rings. (4)



C-10 Solid oak and veneer with white melamine recessed panel with choice of stain and lacquer finish border including (4) miniature low voltage recessed down lights with white trim rings. (5)

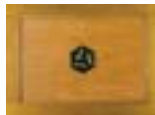

C-11 Solid oak and veneer recessed panel with choice of stain or solid color lacquer finish including 10" diameter, polished brass, (6) sided, beveled glass light fixture. (1)



C-12 Solid oak and veneer raised panel with choice of stain or solid color lacquer finish including (4) miniature low voltage recessed down lights with polished brass trim rings. (4)

CAB OPTIONS



WOOD STAIN SELECTIONS (for Premier, Signature, and Hampton Series cabs)



WHITE 1



NATURAL OAK 2



GOLDEN OAK 3



COLONIAL 4



CHERRY 5



CORDOVAN 6



DARK OAK 7



WALNUT 8

(Stains also available on oak accordion doors)

SOLID COLOR LACQUERS (for Premier, Signature, and Hampton Series cabs)

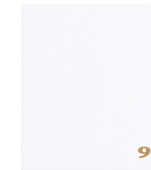

WHITE 9



OFF-WHITE 10

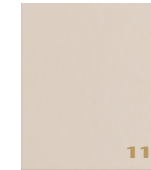

TAN 11

Solid color lacquers are applied to paint grade substrates in lieu of oak.

STANDARD PLASTIC LAMINATE INTERIOR SELECTIONS (for Classic Series cabs)

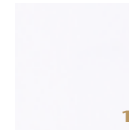

WHITE 1

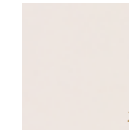

ANTIQUE WHITE 2



BEIGE 3



GREY PAMPAS 4



BEIGE PAMPAS 5



PAMPAS 6



BEIGEWOOD 7



FUSION MAPLE 8

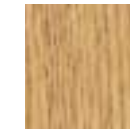

GOLDEN OAK 9



NEPAL TEAK 10

GUNSTOCK WALNUT



11



12

WILD CHERRY



13

FIGURED MAHOGANY

This color selector shows samples that are reproduced using modern printing techniques. Additionally, grain and texture vary in all natural hardwoods. It is therefore not possible to guarantee a match finish.

HANDRAILS



1



3



2



4

HANDRAIL CHOICES

#4 Stainless Steel Rectangular Bar is standard. Others are optional on all series cabs.

- 1 #4 Brushed Stainless Steel Rectangular Bar
- 2 #4 Brushed Brass Rectangular Bar
- 3 #4 Brushed Stainless Steel Cylindrical Bar
- 4 #4 Brushed Brass Cylindrical Bar

#8 Polished Stainless Steel and Brass are available upon request

PUSHBUTTON SIGNAL FIXTURES



1



2



3

#4 Brushed stainless steel shown

CAR OPERATING PANEL

1 The standard car operating panel includes light up pushbuttons, digital floor position indicator with car direction arrows, emergency stop switch, alarm button, and light override switch with #4 brushed stainless steel faceplate. Options include #4 brushed brass, polished stainless or brass faceplates and keyed "lock-out" feature.

HALL STATIONS

2 The standard hall stations include a light up call button and "car here" indicator light with a #4 brushed stainless steel faceplate. Options include #4 brushed brass, polished stainless steel or brass faceplates and keyed "lock-out" feature.

RECESSED PHONE BOX (OPTIONAL)

3 For a more finished look, a recessed phone box will conceal the in-cab phone. Available finishes to match the car operating panel include brushed or polished stainless steel or brass.



1



2



3

#4 Brushed brass shown

ACCORDION DOORS

Solid panel accordion car doors are essential for the safety and security while the elevator car is traveling. The accordion door folds into the cab pocket leaving a maximum clear cab opening for easy access. Our automatic gate operator option will fully open and close the cab door at each landing. This feature eliminates the problem of not being able to call the elevator to another landing in the event that the manually operated cab door was left in the open position.

Consult the factory about our fully automatic car and hoistway door options.



Shown: Natural hardwood oak with golden oak stain and transparent clear acrylic vision panels

OPTIONAL PANEL CHOICES:

NATURAL HARDWOOD OAK: (Available with optional (3) acrylic vision panels)



PANEL CONNECTOR CHOICES:



Available in other wood species with clear lacquer finish including birch, mahogany and walnut *

STANDARD PANEL CHOICES:

VINYL LAMINATES: (Available with optional (3) acrylic vision panels)

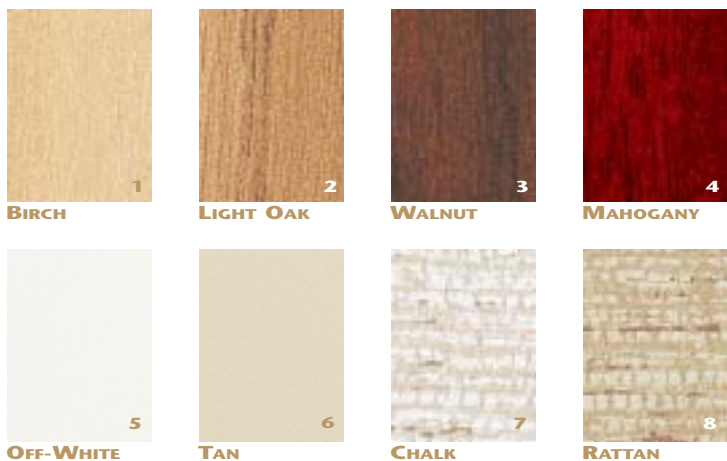

PANEL CONNECTOR CHOICES:



VISIFOLD CHOICES:

(Transparent acrylic panels)

TRANSPARENT BRONZE ACRYLIC **TRANSPARENT CLEAR ACRYLIC**



ALUMIFOLD CHOICES:

(Clear anodized aluminum panels with color coordinated panel connectors)

SOLID PANEL **PERFORATED PANEL**



PANEL CONNECTOR CHOICES:



* This color selector shows samples that are reproduced using modern printing techniques. Additionally, grain and texture vary in all natural hardwoods. It is therefore not possible to guarantee a match finish.

OVERVIEW OF STANDARD FEATURES

CHARACTERISTICS

- Up to 950 lb. capacity (750 lb. standard) *
- 40 f.p.m. nominal car speed
- Up to 6 stops with 50' of floor to floor travel *
- Minimum pit depth of 8" required (10" recommended)
- Minimum overhead clearance of 8'0" required (9'6" recommended)
- Up to 15 square feet interior cab sizes available (12 sq. ft. standard) *

*Consult factory for other custom options.

EQUIPMENT

- 1:2 roped hydraulic drive
- (2) 3/8" diameter hoist cables
- Single stage hydraulic piston and cylinder with pressure balanced self adjusting seal
- Heavy duty cantilevered design car sling with roller guide shoes
- 8 lb. per foot steel tee guide rail system
- 220 volt single phase power supply
- Vibration free submersible pump/motor assembly with 3 or 5 horse-power motor option
- Two speed control valve with (4) solenoids, soft start and stop, and constant down speed regulation

SAFETY DEVICES

- Type "A" instantaneous broken rope car safety
- Pipe rupture valve
- Upper and lower terminal limit switches
- Top final limit switch
- Slack cable switch
- Emergency car lighting in cab
- Emergency push/pull stop switch in cab
- Emergency push button alarm in cab
- Automatic car releveling device
- Floor selectable battery lowering device
- Emergency manual lowering valve
- Emergency telephone in cab
- Solid panel cab doors with approved safety switch
- Approved electro mechanical hoistway door interlocks
- Rubber impact bumper below elevator car
- UL and/or CSA certified electrical and hydraulic devices
- Manufactured in accordance with ASME A17.1 Safety Code

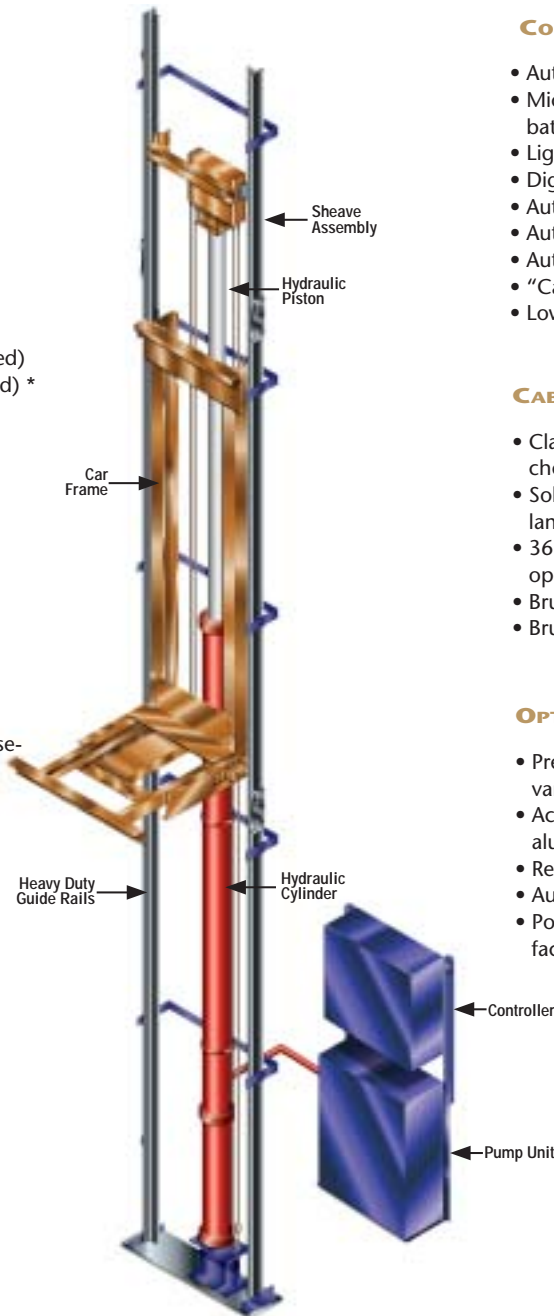

1:2 ROPED HYDRAULIC

CONTROLS/PUSHBUTTON FIXTURES

- Automatic pushbutton control
- Microprocessor based control system with uninterrupted battery back-up
- Light-up pushbuttons in car and hall
- Digital floor position indicator with car direction arrows in car
- Automatic cab lighting with override switch
- Automatic indicator light time-out feature
- Automatic "Home Park" feature to designated floor
- "Car Here" indicator lights in hall
- Low oil protection timer circuit

CAB FINISHES & ACCESSORIES

- Classic Series cab available in a wide variety of plastic laminate choices and other options
- Solid panel accordion cab door available in a wide variety of vinyl laminate choices
- 36" x 48" x 80" high clear interior cab size with a variety of cab opening configurations
- Brushed stainless steel handrail on one sidewall
- Brushed stainless steel cab control panel

OPTIONS

- Premier, Signature, and Hampton Series cabs available in a wide variety of finishes and other options
- Accordion cab doors in hardwood, custom stain and lacquer finish, aluminum, and clear or bronze acrylic panels
- Recessed telephone cabinet
- Automatic car door operator
- Polished stainless steel, brushed brass, or polished brass pushbutton faceplate and handrail finishes

**FOR MORE INFORMATION
CALL OUR TOLL FREE NUMBER:
888-443-2800,
OR VISIT OUR WEBSITE:
WWW.CUSTOMELEVATORINC.COM**

OVERVIEW OF STANDARD FEATURES

CHARACTERISTICS

- Up to 950 lb. capacity (750 lb. standard)
- 40 f.p.m. nominal car speed
- Up to 5 stops with 50' of floor to floor travel
- Minimum pit depth of 8" required (10" recommended)
- Minimum overhead clearance of 9'0" required
- Up to 15 square feet interior cab sizes available (12 sq. ft. standard)

EQUIPMENT

- Overhead winding drum drive
- (2) 3/8" diameter hoist cables
- Environmentally-friendly, low maintenance, space saving machine roomless technology
- Heavy duty cantilevered design car sling with roller guide shoes
- 8 lb. per foot steel tee guide rail system
- 220 volt single phase power supply
- Three horsepower, 3 phase motor with variable voltage, variable frequency (VVVF) drive technology for soft start, soft stop, and smooth operation
- Quiet operating, armature actuated fail safe brake assembly

SAFETY DEVICES

- Type "A" instantaneous broken rope car safety with overspeed governor
- Upper and lower terminal limit switches
- Top final limit switch
- Slack cable switch
- Machine operated final limit switches
- Emergency car lighting in cab
- Emergency push/pull stop switch in cab
- Emergency push button alarm in cab
- Automatic car releveling device
- Automatic battery lowering device
- Emergency manual lowering
- Emergency telephone in cab
- Solid panel cab doors with approved safety switch
- Approved electro mechanical hoistway door interlocks
- Rubber impact bumper below elevator car
- UL and/or CSA certified electrical devices
- Exceeds ASME A17.1 Safety Code Standards for private residence elevators

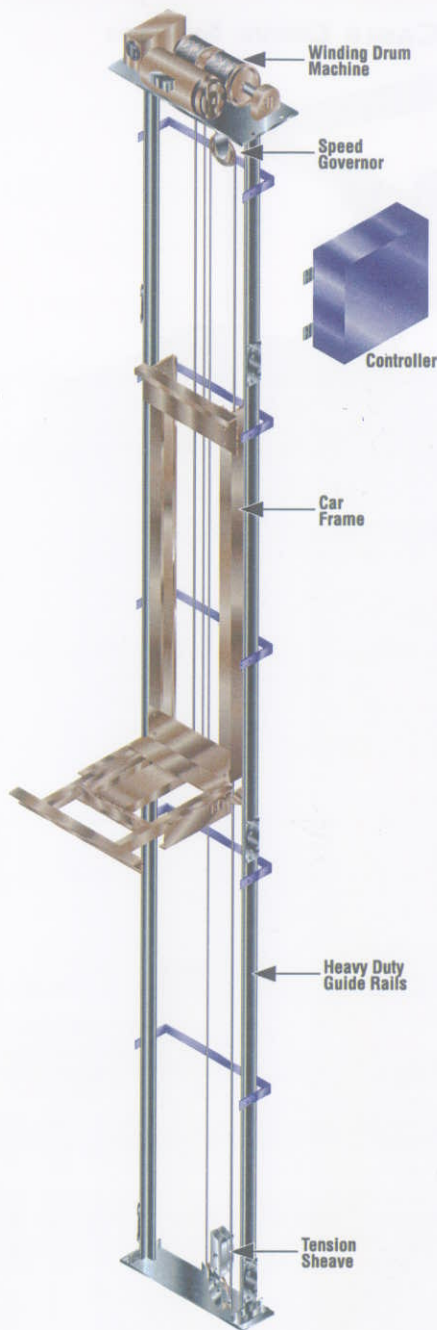

WINDING DRUM

CONTROLS/PUSHBUTTON FIXTURES

- Automatic pushbutton control
- Microprocessor based control system with uninterrupted battery back-up
- Light-up pushbuttons in car and hall
- Digital floor position indicator with car direction arrows in car
- Automatic cab lighting with override switch
- Automatic indicator light time-out feature
- Automatic "Home Park" feature to designated floor
- "Car Here" indicator lights in hall

CAB FINISHES & ACCESSORIES

- Classic Series cab available in a wide variety of plastic laminate choices and other options
- Solid panel accordion cab door available in a wide variety of vinyl laminate choices
- 36" x 48" x 80" high clear interior cab size with a variety of cab opening configurations
- Brushed stainless steel handrail on one sidewall
- Brushed stainless steel cab control panel

OPTIONS

- Premier, Signature, and Hampton Series cabs available in a wide variety of finishes and other options
- Accordion cab doors in hardwood, custom stain and lacquer finish, aluminum, and clear or bronze acrylic panels
- Recessed telephone cabinet
- Automatic car door operator
- Polished stainless steel, brushed brass, or polished brass pushbutton faceplate and handrail finishes

FOR MORE INFORMATION
CALL OUR TOLL FREE NUMBER:
888-443-2800,

OR VISIT OUR WEBSITE:
WWW.CUSTOMELEVATORINC.COM

Signature Classic Hampton Premier Signature Clas
 Hampton Premier Signature Classic Hampton Premier
Signature Classic Hampton Premier Signature Clas
 Hampton Premier Signature Classic Hampton Premier
Signature Classic Hampton Premier Signature Clas
 Hampton Premier Signature Classic Hampton Premier
Signature Classic Hampton Premier Signature Clas
 Hampton Premier Signature Classic Hampton Premier
Signature Classic Hampton Premier Signature Clas
 Hampton Premier Signature Classic Hampton Premier
Signature Classic Hampton Premier Signature Clas
 Hampton Premier Signature Classic Hampton Premier

Custom ELEVATOR

manufacturing
company, inc.

P.O. BOX 749, 5191 STUMP ROAD, PLUMSTEADVILLE, PA 18949

TOLL FREE: 888-443-2800 • PHONE: 215-766-3380 • FAX: 215-766-3385

WWW.CUSTOMELEVATORINC.COM

Signature Classic Hampton Premier Signature Clas
 Hampton Premier Signature Classic Hampton Premier
Signature Classic Hampton Premier Signature Clas